

DEFLECTION ANGLE

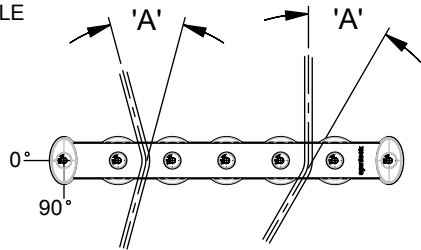

BISECTED ROPE ENTRY

STRAIGHT ROPE ENTRY

DEFLECTION ANGLE, 'A' (°)	MAX ROPE TENSION (KG)
10	3440
15	2300
30	1160
45	780
60	600
90	420

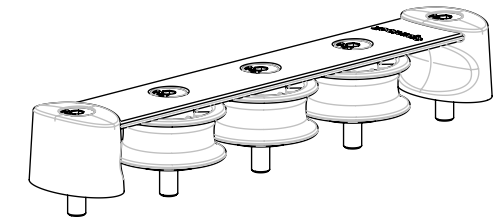

Ø 38 COMPOSITE SHEAVE (T38/3)
ALLOY SHEAVE (T38/3A)

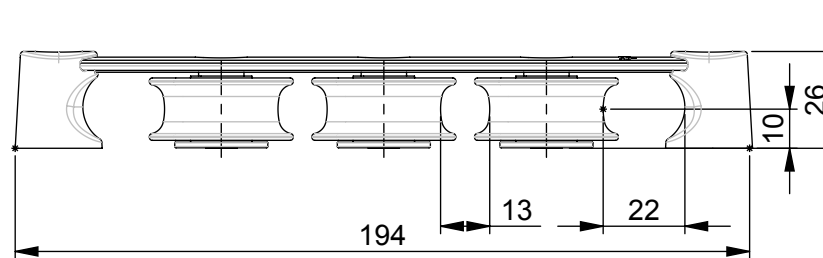
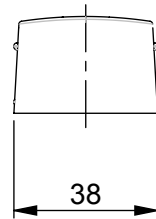
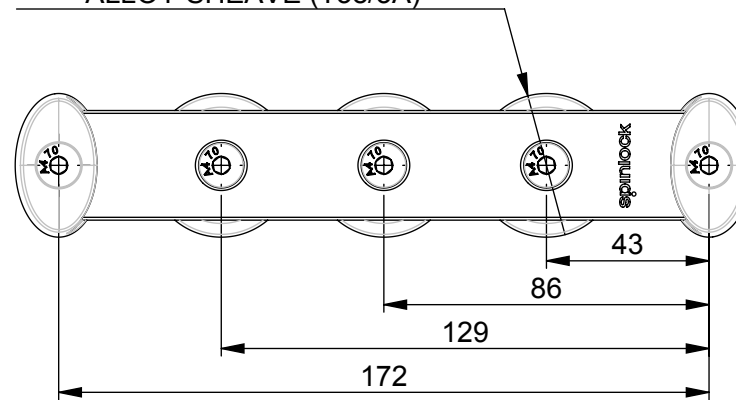

spinlock
BE ADVENTURE-PROOF



WARNING:
IF USING AS DRILL TEMPLATE, ENSURE PRINTER SETTINGS ARE ADJUSTED TO ACCOUNT FOR THE DRAWING SCALE AND **ALWAYS** CHECK DIMENSIONS BEFORE DRILLING.



COPYRIGHT:
THIS DRAWING IS PROTECTED BY COPYRIGHT. ANY USE IS FORBIDDEN WITHOUT THE WRITTEN CONSENT OF SPINLOCK.

ALL DIMENSIONS IN MM

SCALE PAGE SIZE DATE

1:2

A4

MAR 2018

LINE SIZE:
6-12mm
FASTENERS
M6 CSK
x 5

PRODUCT CODE

T38/3

T38/3A

WEIGHT

154g

212g

MAX LOAD

600kg

600kg

MAX LOAD PER UNIT

900kg

900kg

T38/3

FOR ANY MORE INFO CONTACT
SPT@SPINLOCK.CO.UK